



BATTERIES, CHARGERS & ACCESSORIES



For all our latest catalogue updates and company info: www.tvh.be

BATTERIES



VIEW OF OUR BATTERY WAREHOUSE



BATTERIES, CHARGERS & ACCESSORIES



STARTER BATTERY TYPES

DIN Model	DIN Type	Ah 20h	L x W x H (mm)	12V + Position	battery fastening Bx Type	Lt. Acid
524.015.018 REF./ 103TA3048	525.15	24	187 x 128 x 167		B0	1,9
532.011.022 REF./ 103TA3049	532.11	32	233 x 131 x 167		B0	2,5
540.038.030 REF./ 103TA3053	540.38	40	218 x 135 x 225		B1	3,2
540.039.030 REF./ 103TA3054	540.39	40	218 x 135 x 225		B1	3,2
545.077.032 REF./ 106TA8637	545.77	45	218 x 135 x 225		B1	3,1
545.079.032 REF./ 103TA3065	545.79	45	218 x 135 x 225		B1	3,1
540.020.030 REF./ 103TA3050	535.20	40	197 x 129 x 225		B0	2,5
540.022.030 REF./ 103TA3051	535.22	40	197 x 129 x 225		B0	2,5
545.023.032 REF./ 103TA3061	545.23	45	237 x 127 x 223		B0	3,0
545.024.032 REF./ 103TA3062	545.24	45	237 x 127 x 223		B0	3,0
545.051.032 REF./ 106TA8638	545.51	45	237 x 127 x 223		B0	3,0
545.084.032 REF./ 106TA8639	545.84	45	237 x 127 x 223		B0	3,0
536.046.028 REF./ 103TA3052	536.46	36	207 x 175 x 175		B3(B4)	3,0
544.065.033 REF./ 106TA8640	544.65	44	207 x 175 x 175		B3(B4)	3,0
543.017.033 REF./ 103TA3055	543.17	43	207 x 175 x 175		B3	3,0
543.059.030 REF./ 103TA3056	544.59	43	207 x 175 x 190		B3	3,3
544.059.034 REF./ 103TA3056	544.59	44	207 x 175 x 190		B3	3,3
543.064.030 REF./ 103TA3057	544.64	43	207 x 175 x 190		B3	3,3
544.064.034 REF./ 106TA8641	544.64	44	207 x 175 x 190		B3	3,3
555.059.042 REF./ 103TA3070	544.59	55	207 x 280 x 240		B3	3,2
555.064.042 REF./ 106TA8642	544.64	55	207 x 175 x 190		B3	3,2

(*) Small terminals













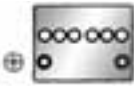









For all our latest catalogue updates and company info: www.tvh.be



BATTERIES, CHARGERS & ACCESSORIES



STARTER BATTERY TYPES

DIN Model	DIN Type	Ah 20h	L x W x H (mm)	12V	 Position	battery fastening  Type	Lt. Acid
550.041.036 REF./ 103TA3068	550.41	50	200 x 170 x 223	12V		B0	3,5
550.042.036 REF./ 103TA3069	550.42	50	200 x 170 x 223			B0	3,5
545.019.036 REF./ 103TA3060	545.19	45	242 x 175 x 175			B3(B4)	3,4
555.019.042 REF./ 106TA8643	555.19	55	242 x 175 x 175			B3(B4)	3,3
560.077.051 REF./ 106TA8644	560.17	60	242 x 175 x 175			B3(B4)	3,2
558.023.051 REF./ 103TA3071	554.23	58	242 x 175 x 175			B3	3,2
555.059.045 REF./ 103TA3074	555.59	55	242 x 175 x 175			B3	3,8
555.065.045 REF./ 103TA3073	555.65	55	242 x 175 x 190			B3	3,8
562.059.048 REF./ 106TA8645	555.59	62	242 x 175 x 190			B3	3,8
562.065.048 REF./ 106TA8646	555.65	62	242 x 175 x 190			B3	3,8
560.068.042 REF./ 103TA3075	560.68	60	230 x 170 x 223			B0	4,1
560.069.042 REF./ 103TA3076	560.69	60	230 x 170 x 223			B0	4,1
560.048.045 REF./ 106TA8647	560.48	60	270 x 175 x 225			B3+B6	5,2
560.049.045 REF./ 106TA8648	560.49	60	270 x 175 x 225			B3+B6	5,2
570.024.054 REF./ 103TA3086	570.24	70	270 x 175 x 225			B3+B6	5,1
570.029.054 REF./ 106TA8649	570.29	70	270 x 175 x 225			B3+B6	5,1
563.018.051 REF./ 106TA8650	563.18	63	275 x 175 x 175			B3(B4)	3,7
568.018.060 REF./ 103TA3085	563.23	68	275 x 175 x 175			B3(B4)	3,6
570.038.054 REF./ 106TA8651	566.38	70	275 x 175 x 190			B3	4,3
570.032.054 REF./ 106TA8652	575.32	70	275 x 175 x 190			B3	4,3
580.031.064 REF./ 103TA3090	575.31	80	275 x 175 x 190		B3	4,2	











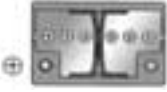









For all our latest catalogue updates and company info: www.tvh.be

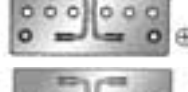

BATTERIES, CHARGERS & ACCESSORIES



STARTER BATTERY TYPES

DIN Model	DIN Type	Ah 20h	L x W x H (mm)	+ Position	battery fastening (Bx) Type	Lt. Acid
580.032.064 REF./ 103TA3091	575.32	80	275 x 175 x 190		B3	4.2
580.035.060 REF./ 106TA8653	580.35	80	310 x 175 x 190		B3	4.5
585.015.072 REF./ 103TA3092	585.15	85	353 x 175 x 175		B3	5.1
588.027.064 REF./ 103TA3093	588.27	88	353 x 175 x 190		B3	5.8
592.027.068 REF./ 106TA8654	588.27	92	353 x 75 x 190		B3	5.7
600.038.076 REF./ 103TA3097	600.38	100	353 x 175 x 190		B3	5.2
600.018.064 REF./ 103TA3095	595.18	100	309 x 175 x 210		B3	5.4
600.032.064 REF./ 106TA8655	600.32	100	309 x 175 x 206		B1	5.4
600.033.064 REF./ 106TA8656	600.33	100	309 x 175 x 206		B1	5.4
600.018.066 REF./ 103TA3095	595.18	100	309 x 175 x 210		B3	5.4
590.017.064 REF./ 106TA8657	590.17	90	343 x 172 x 230		B0	7.2
590.018.064 REF./ 106TA8658	590.18	90	343 x 172 x 230		B0	7.2
605.027.072 REF./ 103TA3099	605.28	105	343 x 172 x 230		B0	6.6
625.026.076 REF./ 103TA3104	625.26	125	343 x 172 x 290		B0	8.1
625.027.076 REF./ 106TA8659	625.27	125	343 x 172 x 290		B0	8.1
610.040.085 REF./ 103TA3100	610.40	110	513 x 175 x 210		B3	8.6
635.044.100 REF./ 103TA3109	635.44	135	513 x 175 x 210		B3	8.2
625.033.085 REF./ 103TA3102	620.33	125	510 x 175 x 225		B3	9.8
650.031.100 REF./ 106TA8660	650.31	150	510 x 175 x 225		B3	9.3
625.034.085 REF./ 103TA3103	620.34	125	510 x 189 x 223		B0	9.6
650.020.100 REF./ 103TA3111	640.20	150	510 x 189 x 223		B0	8.7

12V

BATTERIES, CHARGERS & ACCESSORIES



STARTER BATTERY TYPES

DIN Model	DIN Type	Ah 20h	L x W x H (mm)	12V	+ Position	battery fastening Bx Type	Lt. Acid
630.013.095 REF./ 103TA3107	630.13	130	510 x 216 x 210	12V		B0	11.0
640.011.090 REF./ 103TA3108	632.11	140	510 x 175 x 205			B1	7.5
650.089.100 REF./ 106TA8661	643.89	150	513 x 223 x 223			B3	11.6
650.017.100 REF./ 103TA3112	643.17	150	513 x 223 x 223			B0	11.6
665.014.105 REF./ 106TA8662	665.14	165	513 x 223 x 223			B0	11.3
665.015.105 REF./ 106TA8663	665.15	165	513 x 223 x 223			B3	11.3
680.029.110 REF./ 103TA3117	680.29	180	513 x 223 x 223			B3	10.9
680.022.110 REF./ 103TA3120	680.22	180	513 x 223 x 223			B0	10.9
680.089.110 REF./ 106TA8664	680.89	180	513 x 223 x 223			B3	10.9
700.029.125 REF./ 106TA8665	700.29	200	513 x 223 x 223			B3	10.5
700.088.125 REF./ 106TA8666	700.88	200	513 x 223 x 223			B0	10.5
700.089.125 REF./ 106TA8667	700.89	200	513 x 223 x 223			B3	10.5
720.016.140 REF./ 103TA3124	720.16	220	518 x 273 x 240			B0	15.3
720.018.140 REF./ 103TA3125	720.18	220	518 x 273 x 240			B0	15.3
080.015.045 REF./ 103TA3045	077.15	80	215 x 170 x 190		6V		B6
135.018.085 REF./ 106TA8668	120.18	135	240 x 170 x 230			B0	4.6
165.013.100 REF./ 103TA3047	160.13	165	330 x 175 x 240			B1	6.4

Battery fastening Bx

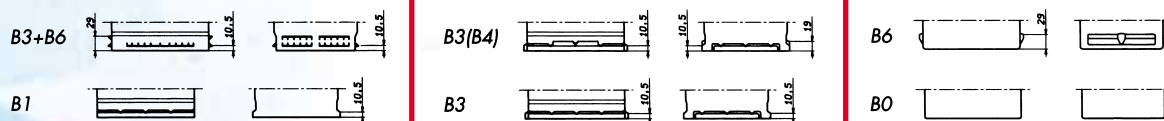

For all our latest catalogue updates and company info: www.tvh.be



BATTERIES, CHARGERS & ACCESSORIES



For all our latest catalogue updates and company info: www.tvh.be

TERMINAL PROTECTION

PLASTIC TERMINAL PROTECTION

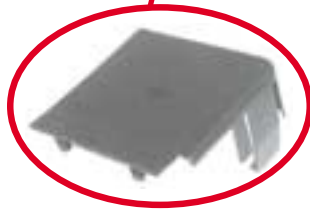

REF./ 106TA6822

RUBBER TERMINAL PROTECTION



REF./ 106TA6823

RUBBER TERMINAL PROTECTION



26 mm² - flush caps
REF./ 106TA8669
26 mm² - standard caps
REF./ 106TA8670



16 mm² - flush caps
REF./ 106TA8671
16 mm² - standard caps
REF./ 106TA8672

REF./ 106TA6824

RUBBER TERMINAL PROTECTION



REF./ 106TA6825



For all our latest catalogue updates and company info: www.tvh.be

TRACTION BATTERIES & CELLS



**For price inquiries,
please list:**

- **Voltage**
- **Ah (Ampere per Hour)**
- **External dimensions of the container**



We also can supply British standard cells



Acid (32%):

Container of 10L: **REF/ 106TA8673**

Container of 20L: **REF/ 106TA8674**

(Not available outside Belgium)

Distilled water:

Container of 10L: **REF/ 106TA8675**

Container of 25L: **REF/ 106TA8676**



20L



10L

BATTERIES, CHARGERS & ACCESSORIES

For all our latest catalogue updates and company info: www.tvh.be



FAX FORM: TRACTION BATTERIES

for price inquiries, please list



Company:
Customer code:
Name:
Fax number:

- Voltage
- Ah (Ampere per Hour)
- External dimensions of the container
L:
W:
H:
- Type of vehicle
- Other accessories required:





BATTERIES, CHARGERS & ACCESSORIES



For all our latest catalogue updates and company info: www.tvh.be

INTER CELL CONNECTORS

LEAD CONNECTORS

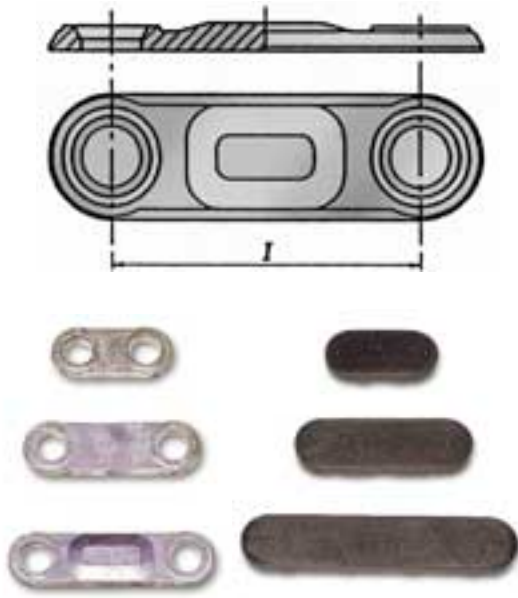

REF./	Connector (l) (mm)	Cover	REF./
106TA8853	46	1	106TA8884
106TA8854	52	1.5	106TA8885
106TA8855	65		
106TA8856	68	2	106TA8886
106TA8857	72		
106TA8858	78		
106TA8859	82	2.5	106TA8887
106TA8860	86		
106TA8861	90		
106TA8862	95	3	106TA8888
106TA8863	98		
106TA8864	100	3.5	106TA8889
106TA8865	104		
106TA8866	109		
106TA8867	115	4	106TA8890
106TA8868	118		
106TA8869	123		
106TA8870	130	5	106TA8891
106TA8871	137		
106TA8872	142		
106TA8873	148		
106TA8874	155	6	106TA8892
106TA8875	160		

FLEXIBLE CONNECTORS

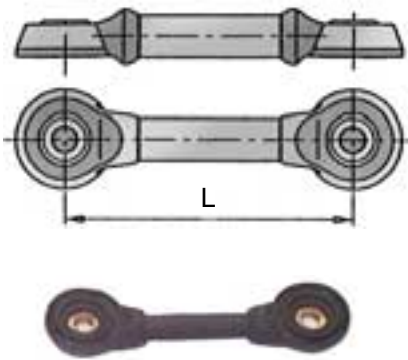

REF./	L (mm) / SECTION. (mm ²)	Ah MAX			
106TA8876	75-25	250	106TA8905	95-50	> 500
106TA8877	85-25	250	106TA8906	85-50	> 500
106TA8878	95-25	250	106TA8907	110-50	> 500
106TA8879	110-25	250	106TA8908	130-50	> 500
106TA8880	130-25	250	106TA8909	150-50	> 500
106TA8881	150-25	250	106TA8910	170-50	> 500
106TA8882	170-25	250	106TA8911	190-50	> 500
106TA8883	190-25	250	106TA8912	210-50	> 500
			106TA8913	250-50	> 500
106TA8893	75-35	500	106TA8914	300-50	> 500
106TA8894	85-35	500	106TA8915	350-50	> 500
106TA8895	95-35	500			
106TA8896	110-35	500			
106TA8897	130-35	500			
106TA8898	150-35	500			
106TA8899	170-35	500			
106TA8900	190-35	500			
106TA8901	210-35	500			
106TA8902	250-35	500			
106TA8903	300-35	500			
106TA8904	350-35	500			

END-CABLE

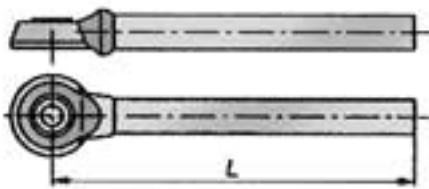

106TA8845	1500-25	250
106TA8846	2000-25	250
106TA8847	1500-35	500
106TA8848	2000-35	500
106TA8849	1500-50	750
106TA8850	2000-50	750
106TA8851	1500-70	> 750
106TA8852	2000-70	> 750





BATTERIES, CHARGERS & ACCESSORIES



For all our latest catalogue updates and company info: www.tvh.be

BATTERY SPACER PLATES - PAINT - CONTAINERS

Spacer plate

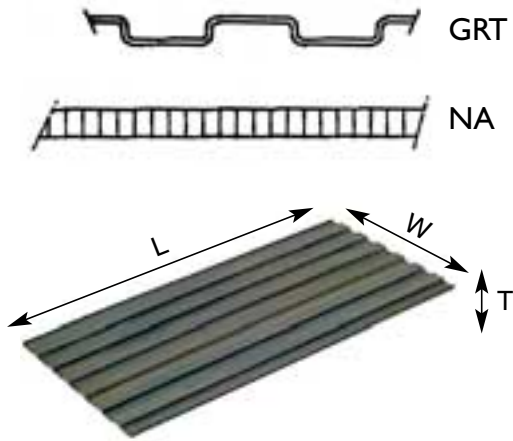

Description	Dimensions WXTXL	REF./
Spacer plate GRT	196x5x325	106TA8916
Spacer plate GRT	196x5x395	106TA8917
Spacer plate GRT	196x5x455	106TA8918
Spacer plate GRT	196x5x505	106TA8919
Spacer plate GRT	196x5x525	106TA8920
Spacer plate GRT	196x5x560	106TA8921
Spacer plate GRT	196x5x685	106TA8922
Spacer plate NA	325x5x2000	106TA8923
Spacer plate NA	395x5x2000	106TA8924
Spacer plate NA	455x5x2000	106TA8925
Spacer plate NA	505x5x2000	106TA8926
Spacer plate NA	525x5x2000	106TA8927
Spacer plate NA	560x5x2000	106TA8928
Spacer plate NA	685x5x2000	106TA8929
Spacer plate NA	1380x5x2000	106TA8930
Spacer plate NA	900x3.5x2000	106TA8931

BATTERY PAINT FOR BOX



black battery paint

REF./ 106TA8932 (5L)



black battery paint

REF./ 106TA8933 (0,5L)

CONIC TERMINAL



Positive : REF./ 107TA9074

Negative : REF./ 107TA9075

COATED BATTERY CONTAINERS TAILORMADE

For inquiries, please mention your external dimensions of the container.





BATTERIES, CHARGERS & ACCESSORIES



For all our latest catalogue updates and company info: www.tvh.be

BATTERY FILLING SYSTEM

Flow Indicator
REF./ 106TA8956



Water Tank
50L : REF./ 106TA8954
20L : REF./ 106TA8955



Female Joint
REF./ 106TA8953

Male Joint
REF./ 106TA8952

Filter H₂O
REF./ 106TA8951

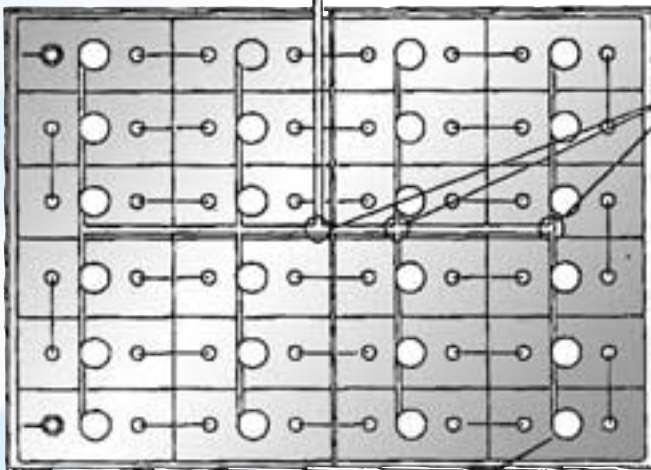

Closing Cup
REF./ 106TA8940



complete part
REF./ 106TA8939



Optional Kit

You can order this optional kit:

- 20L: REF./ 106TA8937 (includes water tank, flow indicator, plastic hose (+/- 3m) and female joint)
- 50L: REF./ 106TA8938 (includes water tank, flow indicator, plastic hose (+/- 3m) and female joint)

Standard Kit

Pipejoints

L-connection 10-6
REF./ 106TA8944



L-connection 10-10
REF./ 106TA8945

T-connection 6-10-6
REF./ 106TA8946



T-connection 10-6-10
REF./ 106TA8947

T-connection 10-10-10
REF./ 106TA8948

X-connection 6-10-6-10
REF./ 106TA8949



X-connection 10-10-10-10
REF./ 106TA8950

You can order this standard kit:

- 24V: REF./ 106TA8934 (includes all the necessary parts for a battery of 24V)
- 48V: REF./ 106TA8935 (includes all the necessary parts for a battery of 48V)
- 80V: REF./ 106TA8936 (includes all the necessary parts for a battery of 80V)

- Plastic hose Ø 5.5mm
REF./ 106TA8941 (metre)
- Plastic hose Ø 9.5mm
REF./ 106TA8942 (metre)
- Plastic hose Ø 11mm
REF./ 106TA8943 (metre)





DEEP-CYCLE BATTERIES



Deep-cycle batteries for access-equipment

REFERENCE	ALTERNATIVE	REF/	V	Ah/20h	L x W x H	Acid
GC2C -PB220 (FT)	T-105	106TA8677	6V	220Ah	262x181x276	4,2 L
GC2B -PB244 (FT)	T-145	106TA8678	6V	244Ah	262x181x276	4,8 L
S4H -PB305 (FT)	T-305	106TA8679	6V	305Ah	305x178x356	11,3 L
LI6 -PB350 (FT)	LI6	106TA8680	6V	353Ah	314x181x419	11,7 L
More on next page						

FT: Full traction





BATTERIES, CHARGERS & ACCESSORIES



For all our latest catalogue updates and company info: www.tvh.be

DEEP-CYCLE BATTERIES

DEEP-CYCLE BATTERIES

REFERENCE	ALTERNATIVE	REF./	V	Ah/20h	L x W x H	Acid
918.01 (ST)	240.15/ EV6	106TA8681	6V	240Ah	244x190x274	6,3 L
6PzS190 (FT)	EV6T	106TA8682	6V	240Ah	244x190x274	6,3 L
PB220/GC2C (FT)	T-105	106TA8677	6V	220Ah	262x181x276	4,2 L
PB244/GC2B (FT)	T-145	106TA8678	6V	244Ah	262x181x276	4,8 L
PB305/S4H (FT)	T-305	106TA8679	6V	305Ah	305x178x356	11,3 L
PB350/LI6 (FT)	LI6	106TA8680	6V	353Ah	314x181x419	11,7 L
955.02 (ST)		106TA8683	12V	60Ah	246x175x190	3,5 L
954.01 (ST)		106TA8684	12V	70Ah	207x175x190	3,1 L
956.02 (ST)	EW75	106TA8685	12V	75Ah	275x175x190	3,7 L
957.51 (ST)	590.21/EW90	106TA8686	12V	90Ah	353x175x190	5 L
958.03 (ST)	600.29/EW100	106TA8687	12V	100Ah	303x175x215	5,5 L
958.02 (ST)		106TA8688	12V	110Ah	415x175x215	5,2 L
958.04 (ST)		106TA8689	12V	115Ah	335x175x230	6 L
3PzS100 (FT)	EW125T	106TA8690	12V	125Ah	345x175x283	8 L
960.02 (ST)	EW125	106TA8691	12V	130Ah	343x175x283	8 L
266 (ST)		106TA8692	12V	140Ah	508x175x228	10 L
960.51 (ST)	630.11/EW140	106TA8693	12V	140Ah	510x189x223	8,4 L
963.51 (ST)	680.25/EW180	106TA8694	12V	180Ah	513x223x223	10 L
968.01 (ST)	730.11/EW230	106TA8695	12V	230Ah	513x273x240	14 L

ST: Semi-traction
FT: Full traction





For all our latest catalogue updates and company info: www.tvh.be

*3 years warranty
on all charger parts!*

ENERGIC Plus^{CE}

TRACTION BATTERY CHARGERS



BATTERY CHARGERS



Multivoltage charger
Three-phase input version

REF./ 106TA8696

24/36/48/72/80 Volt
0 to 100 Amps





BATTERY CHARGERS / THREE PHASE

TRACTION BATTERY CHARGERS



CE

ENERGIC Plus ^{CE}

TRACTION BATTERY CHARGERS

MODEL: RL Digital

Three phase



Ask for our free detailed manuals

- RL box A: REF./ 6262963

- RL box B: REF./ 6262964



TRACTION BATTERY CHARGERS

ENERGIC Plus[®]

TRACTION BATTERY CHARGERS

MODEL: RL Digital

Three phase

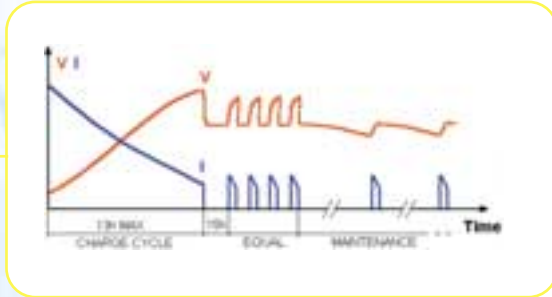

Size (in mm):

Case A



500 x 360 x 700

Case B



500 x 440 x 900

General information (RL DIGITAL)

- Three phase 230/400VAC 50/60Hz input, single phase 230V available on request
- Fully automatic
- CE certificated
- 12 Hour charge system: Wa (DIN41774), 8 Hour charge system: WoWa available on request
- Microprocessor controlled electronic card
- Derivative dV/dT charge control
- Digital display: VOLT/CELL, CURRENT, CAPACITY CHARGED, TIME OF CHARGE
- **Auto-equalise system**
- **Maintenance system**



- Wheel kit (4) available for easy moving:

REF./ 106TA8697 (Case A)



- Wheel kit (4) available for easy moving:

REF./ 106TA8698 (Case B)



New digital technology stands for:

- Increases lifespan of battery
- Built-in maintenance system
- More compact than the older type chargers, so easier to store
- Unbeatable price !
- CE certificated





BATTERIES, CHARGERS & ACCESSORIES



For all our latest catalogue updates and company info: www.tvh.be

BATTERY CHARGERS / THREE PHASE

• (On Stock)

REFERENCE	VOLT	AMP	BATTERY CAPACITY (Ah)	BOX	WEIGHT (Kg)	INPUT POWER (KVA)
MODEL: RL Digital / Three phase						
106TA9180 •	24	60	360	A	57	2,1
106TA9181 •	24	80	480	A	62	2,8
106TA9182 •	24	100	600	A	66	3,5
106TA9183 •	24	120	720	A	68	4,2
106TA8699	24	140	840	A	76	4,9
106TA8700	24	160	960	B	77	5,6
106TA9184 •	36	60	360	A	59	3,1
106TA9185 •	36	80	480	A	64	4,2
106TA9186 •	36	100	600	A	73	5,2
106TA9187 •	36	120	720	A	81	6,2
107TA7661	36	140	840	B	90	7,3
106TA8701	40	50	300	A	45	4,4
106TA8702	40	60	360	A	49	5,3
106TA8703	40	80	480	A	57	4,6
106TA9188 •	48	50	300	A	60	2,8
106TA9189 •	48	60	360	A	66	4,2
106TA9190 •	48	80	480	A	75	5,6
106TA9191 •	48	100	600	A	82	7,0
106TA9192 •	48	120	720	A	89	8,4
106TA8704	48	140	840	B	99	9,8
106TA8705	48	160	960	B	113	11,2
106TA9193 •	72	60	360	A	80	6,3
106TA9194 •	72	80	480	A	88	8,3
106TA8706	72	100	600	B	94	10,5
106TA8707	72	120	720	B	113	12,5
106TA8708	72	140	840	B	122	14,6
106TA9195 •	80	60	360	A	81	6,9
106TA9196 •	80	80	480	A	93	9,2
106TA8709	80	100	600	B	105	11,5
106TA8710	80	120	720	B	117	13,8
106TA8711	80	140	840	B	124	16,1

All spare parts available

Fast chargers on request. Other capacities on request



TRACTION BATTERY CHARGERS



Ask for our free detailed manual
REF./ 6262965



ENERGIC Plus[®]

TRACTION BATTERY CHARGERS

MODEL: RTC

Three phase

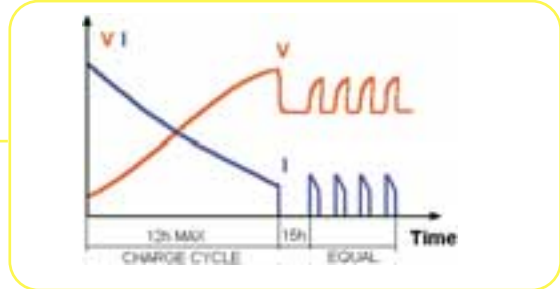

General information (RTC)

- Three phase 230/400VAC 50/60Hz input
- Fully automatic
- CE certificated
- 12 Hour charge system: Wa (DIN41774),
8 Hour charge system: WoWa available on request
- Singlephase version available on request
- Microprocessor controlled electronic card
- Auto-equalise
- Analog amp-meter with shunt

- Wheel kit (4) available for easy moving:
REF./ 106TA8698



Size (in mm):



STANDARD: 500 x 440 x 900
(*) MAX.: 630 x 500 x 1050



• (On Stock)

REFERENCE	VOLT	AMP	BATTERY CAPACITY (Ah)	BOX	WEIGHT (Kg)	INPUT POWER (KVA)
MODEL: RTC / Three phase						
106TA9197 •	24	40	240	A	50	1,4
106TA9198 •	24	60	360	A	57	2,1
106TA9199 •	24	80	480	A	62	2,8
106TA9200 •	24	100	600	A	66	3,5
106TA9201 •	24	120	720	A	68	4,2
106TA9202 •	24	140	840	A	76	4,9
106TA9203 •	24	160	960	A	77	5,6
106TA9204 •	24	200	1200	A	88	7,0
106TA9205 •	36	60	360	A	59	3,1
106TA9206 •	36	80	480	A	64	4,2
106TA9207 •	36	100	600	A	73	5,2
106TA9208 •	36	120	720	A	81	6,2
106TA8712	36	140	840	A	90	7,3
106TA8713	36	160	960	A	95	8,4
106TA8714	36	180	1080	A	104	9,4
106TA8715	36	200	1200	A	110	10,5



BATTERIES, CHARGERS & ACCESSORIES



For all our latest catalogue updates and company info: www.tvh.be

BATTERY CHARGERS / THREE PHASE

• (On Stock)

REFERENCE	VOLT	AMP	BATTERY CAPACITY (Ah)	BOX	WEIGHT (Kg)	INPUT POWER (KVA)
MODEL: RTC / Three phase						
106TA8717	40	50	300	A	50	2,9
106TA8718	40	60	360	A	55	3,5
106TA8719	40	80	480	A	65	4,6
106TA8720	40	100	600	A	74	5,8
106TA9209 •	48	40	240	A	59	2,8
106TA8721	48	50	300	A	63	3,5
106TA9210 •	48	60	360	A	66	4,2
106TA9211 •	48	80	480	A	75	5,6
106TA9212 •	48	100	600	A	82	7,0
106TA9213 •	48	120	720	A	89	8,4
106TA9214 •	48	140	840	A	99	9,8
106TA9215 •	48	160	960	A	113	11,2
106TA8722	48	180	1080	A	122	12,6
106TA8723 Std. fast	48	200	1200	A	132	14,0
106TA9216 •	72	60	360	A	80	6,3
106TA9217 •	72	80	480	A	88	8,3
106TA9218 •	72	100	600	A	94	10,5
106TA9219 •	72	120	720	A	113	12,5
106TA8724	72	140	840	A	122	14,6
106TA8725	72	160	960	A	131	16,6
106TA9220 •	80	40	240	A	70	4,6
106TA9221 •	80	60	360	A	81	6,9
106TA9222 •	80	80	480	A	93	9,2
106TA9223 •	80	100	600	A	105	11,5
106TA9224 •	80	120	720	A	117	13,8
106TA9225 •	80	140	840	A	124	16,1
106TA8726	80	150	900	A	128	17,3
106TA8727	80	160	960	A	129	18,4
106TA8728	80	180	1080	A	135	20,7
106TA8729	80	200	1200	A	142	23,0
106TA8730	80	220	1320	A (*)	180	25,3
106TA8731	80	240	1440	A (*)	185	27,6
106TA8732	80	260	1560	A (*)	190	29,9
106TA8733	80	280	1680	A (*)	195	32,2
106TA8734	96	60	360	A	90	8,4
106TA8735	96	80	480	A	100	11,2
106TA8736	96	100	600	A	118	14,0
106TA8737	96	120	720	A	123	16,8
106TA8738	96	140	840	A	135	19,6
106TA8739	96	160	960	A	148	22,4
106TA8740	96	200	1200	A (*)	180	28,0
106TA8741	96	240	1440	A (*)	195	33,6
106TA8742	96	260	1560	A (*)	205	36,4
106TA8743	96	280	1680	A (*)	215	39,2
106TA8744 Std. fast	96	320	1920	A (*)	230	44,8

All spare parts available

Fast chargers on request. Other capacities on request



TRACTION BATTERY CHARGERS

ENERGIC Plus[®]



Ask for our free detailed manuals

- RE box A: REF./ I07TA8376
- RE box B: REF./ I07TA8377
- RE box C: REF./ I07TA8378
- RE box S: REF./ I07TA8761



CE

TRACTION BATTERY CHARGERS

MODEL: RE

Single phase

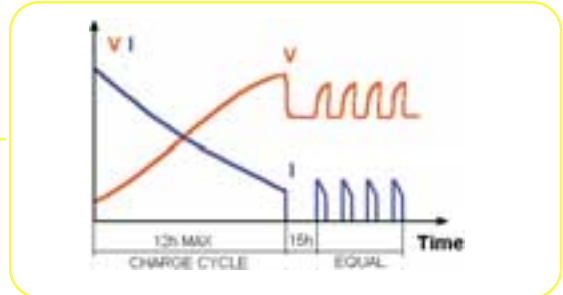

Size (in mm):

Box S



250 x 200 x 320

Box A



430 x 285 x 270

Box B



500 x 340 x 360

Box C



500 x 360 x 700

General information (RE)

- Single phase 230VAC 50/60Hz input
- Fully automatic
- CE certificated
- 12 Hour charge system: Wa (DIN41774),
8 Hour charge system: WoWa available on request
- Microprocessor controlled electronic card
- Equalization
- Amp-meter
- Other versions available on request

Parts available!





BATTERIES, CHARGERS & ACCESSORIES



• (On Stock)

For all our latest catalogue updates and company info: www.tvh.be

BATTERY CHARGERS / SINGLE PHASE

REFERENCE	VOLT	AMP	BATTERY CAPACITY (Ah)	BOX	WEIGHT (Kg)	INPUT POWER (KVA)
MODEL: RE / Single phase						
<i>106TA9226 •</i>	12	10	60	S	10	0,16
<i>106TA9227 •</i>	12	15	80	S	12	0,25
<i>106TA9228 •</i>	12	20	120	S	12	0,33
<i>106TA8745</i>	12	25	150	S	13	0,40
<i>106TA9229 •</i>	12	30	180	S	14	0,50
<i>106TA9230 •</i>	12	40	240	S	17	0,65
<i>106TA9231 •</i>	12	50	300	A	25	0,80
<i>106TA8746</i>	12	60	360	A	27	1,00
<i>106TA8747</i>	12	80	480	B	32	1,30
<i>106TA9232 •</i>	24	10	60	S	14	0,33
<i>106TA9233 •</i>	24	15	80	S	14	0,50
<i>106TA9234 •</i>	24	20	120	S	14	0,65
<i>106TA9235 •</i>	24	25	150	S	15	0,80
<i>106TA9236 •</i>	24	30	180	A	20	1,00
<i>106TA9237 •</i>	24	40	240	A	21	1,30
<i>106TA9238 •</i>	24	50	300	A	24	1,60
<i>106TA9239 •</i>	24	60	360	A	26	2,00
<i>106TA9240 •</i>	24	80	480	B	37	2,60
<i>106TA9241 •</i>	24	100	600	B	43	3,20
<i>106TA9242 •</i>	24	120	720	C	45	4,00
<i>106TA8748</i>	24	140	840	C	53	4,60
<i>106TA9243 •</i>	36	30	180	A	23	1,50
<i>106TA9244 •</i>	36	40	240	A	25	2,00
<i>106TA9245 •</i>	36	50	300	B	33	2,40
<i>106TA9246 •</i>	36	60	360	B	35	3,00
<i>106TA9247 •</i>	36	80	480	B	59	4,00
<i>106TA9248 •</i>	36	100	600	C	65	4,80
<i>106TA8749</i>	36	120	720	C	69	6,00
<i>106TA8750</i>	40	50	300	B	35	2,88
<i>106TA8751</i>	40	60	360	B	38	3,45
<i>106TA8752</i>	40	80	480	C	62	4,60
<i>106TA8753</i>	40	100	600	C	67	5,75
<i>106TA8754</i>	48	10	60	S	19	0,65
<i>106TA9249 •</i>	48	15	80	A	22	1,00
<i>106TA9250 •</i>	48	30	180	A	25	2,00
<i>106TA9251 •</i>	48	40	240	B	35	2,60
<i>106TA9252 •</i>	48	50	300	B	39	3,25
<i>106TA9253 •</i>	48	60	360	B	45	4,00
<i>106TA9254 •</i>	48	80	480	C	54	5,20
<i>106TA9255 •</i>	48	100	600	C	59	6,50
<i>106TA8755</i>	48	120	720	C	65	8,00
<i>106TA9256 •</i>	72	60	360	C	59	6,00
<i>106TA9257 •</i>	72	80	480	C	64	8,00
<i>106TA9258 •</i>	72	100	600	C	70	9,60
<i>106TA9259 •</i>	80	40	240	C	63	4,60
<i>106TA9260 •</i>	80	60	360	C	70	6,90
<i>106TA9261 •</i>	80	80	480	C	78	9,20

Also available in 96 V. Fast chargers on request. Other capacities on request

All spare parts available



TRACTION BATTERY CHARGERS



1. What is EQUALIZATION and how it works ?

When a battery is new, all the cells are virtually in the same condition. After the first cycle of charge-discharge, you can already measure small tension differences between the cells. These small differences between cells, in the next charge-discharge cycles, are more and more emphasized. This process reduces the performance of the battery and its life span. The EQUALIZATION function, **performed by all Energic Plus chargers**, has been developed to keep all the cells of the battery at the same level, even after years of continuous work.

The equalization function consists of 4 short extra charge cycles after the normal charge of the battery is completed. In the diagram of our chargers (see picture), it is possible to see the 4 equalization charges.

ADVANTAGES:

- Improvement of the battery performance
- Extended battery life span

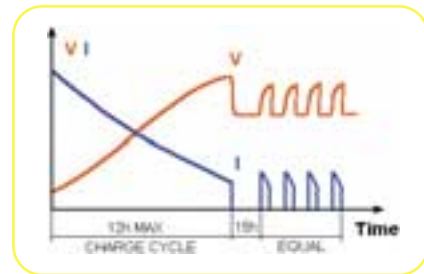

2. What is MAINTENANCE and how it works ?

If a battery is not used for a long time (example: seasonal works, holiday periods), it must be kept fully charged, in order to avoid a fall in performance.

Then it is important TO CHARGE THE BATTERY PRIOR TO LEAVING IT IN STOCK FOR MORE THAN 24 HOURS. Another problem is present in all batteries: the AUTO-DISCHARGE process. This makes it harder to keep a battery charged when the time of stocking is longer (weeks or months).

The MAINTENANCE function, **performed by our RL DIGITAL chargers**, keeps the battery in perfect condition when it is not used for an indefinite time. It is sufficient to leave the battery connected to the charger and the maintenance function will be done automatically.

Our RL DIGITAL constantly monitors the battery voltage and maintains it between 2.25 and 2,37V/cell, so the maintenance timing is "controlled" by the battery.

The most important advantages of RL DIGITAL chargers are:

• DERIVATIVE dV/dT FINAL CHARGE

The time of charge is completely defined by the battery conditions

The risk of overheats in the battery is eliminated

The risk of insufficient charge in the battery is eliminated

The charger stoppes when the battery is fully charged

• DIGITAL DISPLAY WITH ADVANCED INFORMATIONS

The display continuously shows the charge parametres (current, capacity charged, effective time of charge, volt/cell) The display shows special messages in case of emergency stop, errors, black-out, to help the operation of troubleshooting (see user manuals).

The parametres CAPACITY CHARGED and EFFECTIVE TIME OF CHARGE are required to enable complete control of the battery performance, especially when it's necessary to find the cause of a low autonomy of the forklift.



BATTERIES, CHARGERS & ACCESSORIES



For all our latest catalogue updates and company info: www.tvh.be

PANELS FOR BATTERY CHARGERS - SPIRAL CABLES

PANELS FOR BATTERY CHARGERS



CHARGER	BOX	DESCRIPTION	REF./
ANALOGUE AMP METER: (serial number < 50.000)			
RE	A	BASE	106TA8756
RE	A	COVER PANEL	106TA8757
RE	B	BASE	106TA8758
RE	B	COVER PANEL	106TA8759
RE	C	BASE	106TA8760
RE	C	SIDE PANEL	106TA8761
RE	C	TOP PANEL	106TA8762
RE	C	REAR PANEL	106TA8763



DIGITAL AMP METER: (serial number > 50.000)			
RE	S	BASE	107TA8754
RE	S	COVER	107TA8755
RE	A	BASE	107TA8756
RE	A	COVER	107TA8757
RE	B	BASE	107TA8758
RE	B	COVER	107TA8759
RE	C	BASE	106TA8760
RE	C	SIDE	106TA8761
RE	C	TOP	106TA8762
RE	C	REAR	106TA8763

RL



RL	A	BASE	106TA8760
RL	A	SIDE PANEL	106TA8761
RL	A	TOP PANEL	106TA8762
RL	A	REAR PANEL	106TA8763
RL	B	BASE	106TA8764
RL	B	SIDE PANEL LEFT	106TA8765
RL	B	SIDE PANEL RIGHT	106TA8766
RL	B	TOP PANEL	106TA8767
RL	B	REAR PANEL	106TA8768
RL	B	FRONT PANEL (DOOR)	106TA8769

RTC		BASE	106TA8764
RTC		SIDE PANEL LEFT	106TA8765
RTC		SIDE PANEL RIGHT	106TA8766
RTC		TOP PANEL	106TA8767
RTC		REAR PANEL	106TA8768
RTC		FRONT PANEL (DOOR)	106TA8770

SPIRAL CABLE



European continent only!



Male plug:
REF./ 106TA6338



Male & female plug:
REF./ 106TA6339



VOLTMETERS



60 x 65 mm
0 - 50 V
0 - 100 V

REF./ 106TA8775
REF./ 106TA8776

Rear body: Ø 45 mm



100 x 124 mm
0 - 50 V
0 - 100 V

REF./ 106TA8777
REF./ 106TA8778

Rear body: Ø 45 mm

AMP METERS EXTERNAL SHUNT



60 x 65 mm
0 - 50 A
0 - 150 A

REF./ 106TA8773
REF./ 106TA8774

Rear body: Ø 45 mm

SHUNT FOR AMP METERS



50 A - 60 mV
150 A - 60 mV

REF./ 106TA8771
REF./ 106TA8772



AMPMETERS INTERNAL SHUNT



72 x 62 mm

0 - 20 A

0 - 30 A

0 - 50 A

0 - 80 A

REF./ 106TA8779

REF./ 106TA8780

REF./ 106TA8781

REF./ 106TA8782

Rear body: Ø 70 mm



92 x 82 mm

0 - 50 A

0 - 80 A

REF./ 106TA8783

REF./ 106TA8784

Rear body: Ø 70 mm



A full range of charger spares held for energetic plus.

For other makes, please supply full charger details!



For all our latest catalogue updates and company info:

www.tvh.be

or ask your on-line ordering and pricing connection with TVH "TVH-QUICK PRICE"

use e-mail: ecommerce@tvh.be for more info



1. MULTI-VOLTAGE KIT: TYPE 473SCE WITH EQUALISATION (24-80V)



24-80V REF./ 105TA2756



These retrofit kits are designed to replace old controller systems and update to the latest safety specifications.

All retrofit kits:

- come with auto-equalisation as standard.
- are supplied with full installation manuals.
- have an integrated test function for checking the installation.

2. SINGLE VOLTAGE KITS : TYPE 422SCE WITH EQUALISATION (12V-24V-36V)

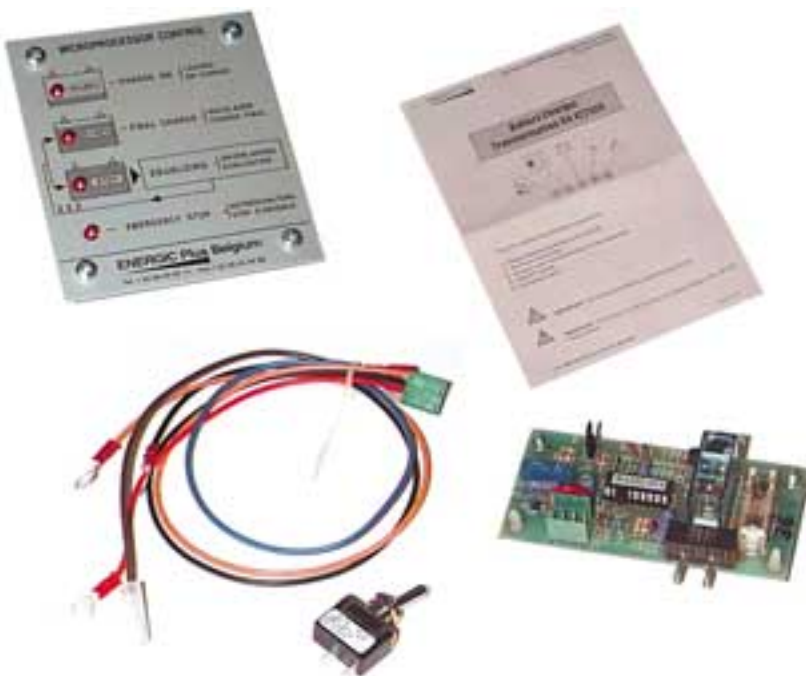

12V	REF./ 105TA2753
24V	REF./ 105TA2754
36V	REF./ 105TA2755

Universal retrofit kit for your old charger!





BATTERIES, CHARGERS & ACCESSORIES



Charging curve IU1a



HIGH FREQUENCY BATTERY CHARGERS



(285 x 105 x 75)

REF./	SINGLE PHASE (built in chargers for pallet trucks)				Recommended battery capacity
	Type	Nominal battery voltage	Output current		
I06TA8802	BCI 12-15	12V	15 A		100-160 Ah
I06TA8803	BCI 12-30	12V	30 A		160-240 Ah
I06TA8804	BCI 12-35	12V	35 A		180-300 Ah
I06TA8805	BCI 24-20	24V	20 A		80-160 Ah
I06TA8806	BCI 24-25	24V	25 A		150-200 Ah
I06TA8807	BCI 24-30	24V	30 A		200-250 Ah



(300 x 160 x 78)

REF./	SINGLE PHASE					Recommended battery capacity
	Type	Nominal battery voltage	Output current	Absorbed max. power		
I06TA8798	NG1 12-50	12V	50A	850W		260-500Ah
I06TA8799	NG1 24-30	24V	30A	1000W		160-300Ah
I06TA8800	NG1 36-20	36V	20A	1000W		100-200Ah
I06TA8801	NG1 48-15	48V	15A	1000W		80-150Ah



(425 x 215 x 90)

REF./	SINGLE PHASE				Recommended battery capacity
	Type	Nominal battery voltage	Output current		
I06TA8808	NG3 12-100	12V	100 A		500-1000 Ah
I06TA8809	NG3 24-50	24V	50 A		250-500 Ah
I06TA8810	NG3 24-80	24V	80 A		400-800 Ah
I06TA8811	NG3 36-60	36V	60 A		300-600 Ah
I06TA8812	NG3 48-50	48V	50 A		250-500 Ah
I06TA8813	NG3 60-35	60V	35 A		175-350 Ah
I06TA8814	NG3 72-30	72V	30 A		150-300 Ah
I06TA8815	NG3 80-27	80V	27 A		135-270 Ah
I06TA8816	NG3 84-25	84V	25 A		125-250 Ah
I06TA8817	NG3 96-22	96V	22 A		110-220 Ah
I06TA8818	NG3 108-20	108V	20 A		100-200 Ah
I06TA8819	NG3 120-18	120V	18 A		90-180 Ah
I06TA8820	NG3 132-16	132V	16 A		80-160 Ah
I06TA8821	NG3 144-15	144V	15 A		75-150 Ah
I06TA8822	NG3 156-14	156V	14 A		70-140 Ah
I06TA8823	NG3 168-13	168V	13 A		65-130 Ah
I06TA8824	NG3 180-12	180V	12 A		60-120 Ah
I06TA8825	NG3 192-11	192V	11 A		55-110 Ah
I06TA8826	NG3 216-10	216V	10 A		50-100 Ah



(550 x 260 x 130)

REF./	THREE PHASE					Recommended battery capacity
	Type	Nominal battery voltage	Output current	Output current WUIa		
I06TA8785	NG5 24-100	24V	100A	-		500-1000Ah
I06TA8786	NG5 36-100	36V	100A	-		500-1000Ah
I06TA8787	NG5 48-80	48V	80A	95A		400-800Ah
I06TA8788	NG7 48-100	48V	100A	-		400-1000Ah
I06TA8789	NG5 72-55	72V	55A	65A		275-550Ah
I06TA8790	NG7 72-70	72V	70A	85A		280-700Ah
I06TA8791	NG9 72-100	72V	100A	-		400-960Ah
I06TA8792	NG5 80-50	80V	50A	60A		250-500Ah
I06TA8793	NG7 80-65	80V	65A	75A		325-650Ah
I06TA8794	NG9 80-80	80V	80A	95A		320-780Ah
I06TA8795	NG5 84-45	84V	45A	55A		225-450h
I06TA8796	NG5 96-40	96V	40A	50A		200-400Ah
I06TA8797	NG5 120-30	120V	30A	35A		150-300Ah

For all our latest catalogue updates and company info: www.tvh.be



BATTERIES, CHARGERS & ACCESSORIES



For all our latest catalogue updates and company info: www.tvh.be

BATTERY CHARGERS 6 - 12 & 24 VOLT

6-12V
1,5-3 A arith.

2-5 A eff.
150x90x130 mm.
1,455 Kg.

Charger
REF./ 106TA8834



12-24V
6-12 A arith.

8,5-17 A eff.
290x170x240 mm.
10,390 Kg.

Charger tester
REF./ 106TA8830



12V
5 A arith.

7A eff.
210x125x160 mm.
2,320 Kg.

Charger
REF./ 106TA8835



12-24V
8-16 A arith.

11-22,5 A eff.
290x170x240 mm.
10,640 Kg.

Charger tester
REF./ 105TA8897



12V
4-8 A arith.

5,5-11 A eff.
210x125x160 mm.
3,500 Kg.

Charger
REF./ 106TA8833



12-24V
10-20 A arith.

14-28 A eff.
290x170x240 mm.
11,370 Kg.

Charger tester
REF./ 106TA8829



12-24V
4-8 A arith.

5,5-11 A eff.
210x125x160 mm.
4,400 Kg.

Charger
REF./ 106TA8832



12V
3 A arith.

5 A eff.
automatic
150x90x130 mm.
1,460 Kg.

Charger tester
REF./ 106TA8828



6-12V
6-12 A arith.

8,5-17 A eff.
250x145x200 mm.
6,270 Kg.

Charger
REF./ 106TA8831



12-24V
4-8 A arith.

5,5-11 A eff.
automatic
210x125x160 mm.
4,430 Kg.

Charger tester
REF./ 106TA8827





PLUGS 380 V

PLUGS 380 V - ACCORDING TO C.E. REGULATIONS



Made according to following approvals.
IP44
IEC60309-1 & 2
EN60309-1 & 2



female



16A REF./ 106TA6750

32A REF./ 106TA6751



16A REF./ 106TA6752

32A REF./ 106TA6753



male



16A REF./ 106TA6754

32A REF./ 106TA6755



16A REF./ 106TA6756

32A REF./ 106TA6757



male



16A REF./ 106TA6758

32A REF./ 106TA6759



16A REF./ 106TA6760

32A REF./ 106TA6761



female



16A REF./ 106TA6762

32A REF./ 106TA6763



16A REF./ 106TA6764

32A REF./ 106TA6765



BATTERIES, CHARGERS & ACCESSORIES



For all our latest catalogue updates and company info: www.tvh.be

BATTERY TRANSPORT SYSTEMS

TROLLEY (300 KG)



REF./ 106TA8844

Lightweight foldable platform trolley
capacity: 300 kg

TROLLEY (250 KG)



REF./ 106TA8843

Hand Trolley in aluminium
capacity: 250 kg

TROLLEY (150 KG)



REF./ 105TA4563

Lightweight foldable platform trolley
capacity: 150 kg

BATTERY CARRYING HARNESS



REF./ 106TA8842

Universal battery carrier with handle

BATTERY CARRYING HARNESS



REF./ 106TA8840

battery carrier
2 arms

REF./ 106TA8841

battery carrier 3 arms

LIFTING HARNESS

REF/ 106TA8839

lifting harness
for traction
batteries
4 hooks
1500kgs
capacity



LIFTING HOOK



REF./ 106TA8838

To remove traction
batteries from forklifts
Supplied with hooks,
without lifting chains



CE

BATTERY CHANGING BEAMS



Lifting beams are specifically designed to remove and replace forklift truck batteries safely and economically without the risk of damage. Supplied complete with 4 single leg chain slings. Secured safely to the forks by thumb screws.

REF/ number	Capacity	Max fork section	Distance between 2 hooks (width)	Distance between 2 hooks (width)	Weight
	Kg	MM	MM	MM	Kg
106TA8836	1000	150x60	450	1200	30
106TA8837	2000	150x60	450	1200	35

CE



BATTERIES, CHARGERS & ACCESSORIES



For all our latest catalogue updates and company info: www.tvh.be

BATTERY TESTING EQUIPMENT

Car electronic tester

REF./ 106TA8960

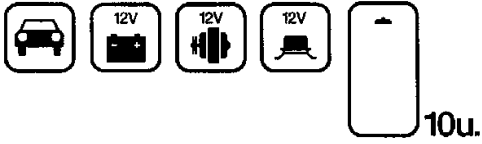

Digital voltmeter

REF./ 106TA8959

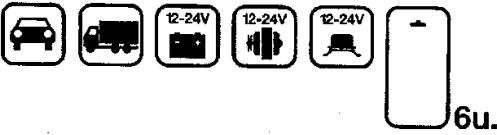

Electronic tester

REF./ 106TA8958

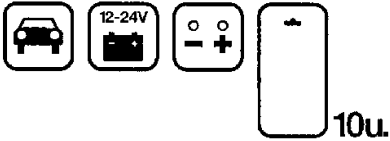

Electronic tester

REF./ 106TA8957

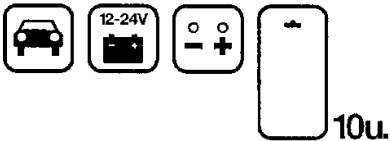

POCKET MULTIMETER



REF./ 106TA8963
Digital multimeter

MULTIMETER



REF./ 106TA8962
Multimeter with 2 leads

CLAMP METER



REF./ 106TA8961
upto 1000A - 600v - AC/DC



BATTERY CELL TESTER



battery cell tester

REF./ 106TA8967 - 2 Volt 250A

REF./ 106TA8968 - 2 Volt 375A

12 VOLT BATTERY CHECKER



Specification

- digital read out: Volt $\pm 0,1$ V
- rate of discharge at 12 volts 10 - 200 - 300 amps
- take readings after 5 seconds and hold reading for 10 seconds
- polarity indicator via diodes

REF./ 106TA8969

START BOOSTER



REF./ 106TA8966

portable engine starter booster

- 12 volt
- 1600 A maximum
- 600 A continuous

REF./ 106TA8965

Starttruck 12-24 V

BATTERY CAPACITY TESTER

REF./ 107TA9073

Battery voltage: 2-160 V

Discharge current: 1-75 Amp

REF./ 106TA8964

Battery voltage: 2-80 V

Discharge current: 1-150 Amp

Indispensable to check the efficiency of a battery, whether it is new or used. It allows the measurement of the amp/h delivered by the battery before reaching the level at which it is considered down (usually 1.7V/ell). Anyway this stop voltage level is adjustable.

The discharger is fitted with a display on which the follow parametres are shown:

- the battery voltage
- the selected stop voltage (this value is selected automatically on 70% of battery voltage's value, so it's necessary to change it if it isn't the desired value).
- the level of discharging current.
- the lapse time from beginning of discharging
- the A/h discharged

Technical features:

- power supply (one unit)
- tolerance of reading value
- maximum time limit
- mechanical dimensions
- weight (one unit)
- thermic protection
- overvoltage protection
- reverse polarity protection



220V AC 50-60 Hz
110V AC (if request)
300W max.
 $\pm 2\%$
9h 59 min.
465 x 265 x 400
26 Kg



DISTILLED WATER STATION



Time and space are very expensive. Each year large sums of money are spent on the maintenance of batteries with old and non-adapting material. To help you find a solution for this problem, we are now distributing battery water dispensing stations. These stations produce and distribute pure distilled water.

Fixed stations: (up to 20 forklifts)

This kind of station can be wall mounted and operated directly from a pressurised drinking water supply.

They are supplied with two de-ionisation cartridges (capacity: 2x500L), 5 metre flexible cable and a dispensing gun.

The deionisation cartridges include a colour change exhaustion indicator window, which indicates the degree of consumption.

Complete station
with standard gun

REF./ 106TA8970



Replacement cartridge:
Dimensions L x H x W

REF./ 106TA8971
86,5 x 30,5 x 11,5 cm



Standard dispensing gun
(Without level sensor)

REF./ 106TA8972



Dispensing gun with level sensor

REF./ 106TA8973



BATTERIES, CHARGERS & ACCESSORIES



For all our latest catalogue updates and company info: www.tvh.be

WATER STATION WITH RESERVOIR - SUCTION PUMPS

DEMINEALISED WATER UNIT



REF./ 105TA4903

Can produce 150 L demineralised water

REF./ 105TA4902

Replacement cartridge

WATER DEMINEALISER COMPLETE WITH RESERVOIR

REF./ 103TA1549 (Complete system)

The long experience acquired in the area of the fork lift trucks lead to the production of Vinky.

Vinky is an efficient and easy device to use that will prove to be of use to personnel responsible for refilling water within traction batteries.

The Vinky can produce 500 litres of demineralised water delivered with gun (with auto-level detector) and reservoir of 15 litres.

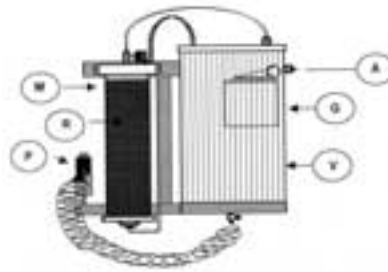

Face 1:
general drawing of the system of Vinky balance



For further details please ask for our complete information leaflet: REF./ 103TA1550

Code	Description	REF/
P	Gun	REF./ 103TA1551
M	Demineraliser (= resin + tube)	REF./ 103TA1552
R	Synthetic demineralising resin (no tube)	REF./ 103TA1553
G	Sender unit to stop water overflowing	REF./ 103TA1554
V	Tank for demineralised water Capacity 15 L Dimensions : 206 x 166 x 461	REF./ 103TA1555

BATTERY SUCTION PUMPS



12 volt suction pump for emptying water from battery boxes

mobile unit

REF./ 106TA8975



12 volt suction pump for emptying water from battery boxes

fixed unit on stand

REF./ 106TA8974



BATTERIES, CHARGERS & ACCESSORIES



For all our latest catalogue updates and company info: www.tvh.be

BATTERY FILLING UNITS

BATTERY FILLER UNIT



REF./ 106TA8981

automatic battery acid filling on trolley (220 volt)
for use in workshop

BATTERY FILLER UNIT



REF./ 106TA8980

automatic battery acid filling (220 volt)
for van-use, easy to move

BATTERY FILLER UNIT



REF./ 106TA8979

professional unit for filling starter batteries
for filling 1 cell at a time

BATTERY FILLER UNIT



REF./ 106TA8978

professional unit for filling starter batteries
for filling 3 cells at one time

BATTERY FILLER UNIT



REF./ 106TA8977

mobile battery filler unit with filler gun.
(50 L capacity tank) - 12V pump

BATTERY FILLER UNIT



SPECIAL
OFFER



NEW IN
PROGRAMME



REF./ 106TA8976

Mobile water filling system with 60L barrel
battery of 12V 6,5Ah



BATTERIES, CHARGERS & ACCESSORIES



For all our latest catalogue updates and company info: www.tvh.be

BATTERY ACCESSORIES

BATTERY ACCESSORIES



REF./ 106TA8987
hydrometer

BATTERY ACCESSORIES

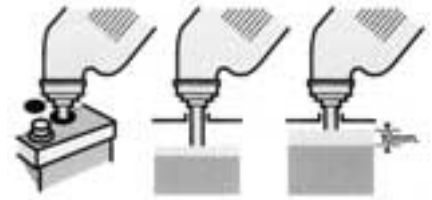

water topping up bottle
0,5 L **REF./ 106TA8982**
1 L **REF./ 106TA8983**

SUCTION HAND PUMP



REF./ 105TA4900
handpump with 9 L reservoir for emptying water from battery boxes

BATTERY ACCESSORIES



REF./ 106TA8988
acid filling pistol

WATER FILLING PISTOL



REF./ 103TA1551
water filling pistol complete with automatic level detector

LEVEL DETECTOR

REF./ 106TA8989
4 volt level indicator with lamp
lamp switches off when correct level is reached



FILLING PUMP



REF./ 106TA8986
manual battery filling pump

REAMER



REF./ 106TA8984
Battery terminal reamer

BRUSH CLEANING SET



REF./ 106TA8985
brushes for battery starter terminals



BATTERIES, CHARGERS & ACCESSORIES



For all our latest catalogue updates and company info: www.tvh.be

BATTERY ACCESSORIES

PUMP



REF./ 106TA8996
semi automatic acid pump

ELECTRONIC CIRCUIT TESTER



REF./ 106TA8990

CONTAINER



REF./ 106TA8992
Container for storing batteries

REF./ 106TA8993
container cover

PUNCHES



REF./ 106TA8994
set of letters

REF./ 106TA8995
set of numbers/symbols

BATTERY PROTECTION SPRAY



REF./ 107TA7662

Battery cleaner with acid indicator

- eliminates corrosion
- provides corrosion prevention
- turns pink in the presence of acid

ACID RESISTANT FUNNEL



REF./ 107TA7663
acid resistant funnel

BATTERY GREASE



REF./ 106TA8991
tube of anti-corrosive grease for battery terminals (20 ml)



BATTERIES, CHARGERS & ACCESSORIES



For all our latest catalogue updates and company info: www.tvh.be

ALKALINE BATTERIES - BATTERY SAFETY PRODUCTS

BATTERY



REF./ 106TA9003
Duracell battery 4,5V
1 unit

BATTERY



REF./ 106TA9002
Duracell C, 1.5V
Packing of 2 units

BATTERY



REF./ 106TA9001
Duracell AA, 1.5V
Packing of 4 units

BATTERY



REF./ 106TA9000
Duracell AAA, 1.5V
Packing of 4 units

BATTERY



REF./ 106TA8999
Duracell 9V
1 unit

BATTERY



REF./ 106TA8998
Duracell D, 1.5V
Packing of 2 units



SAFETY



REF./ 106TA9006
eye washing bottle
400 ml

REF./ 106TA9007
eye washing bottle
800 ml

REF./ 106TA9008
holder



REF./ 106TA9005
Eye washing bottle kit
complete with sterile bandages etc



REF./ 106TA9004
emergency first aid kit complete with
splint, tongs, plasters and eye wash
etc



REF./ 106TA8997
first aid box





BATTERIES, CHARGERS & ACCESSORIES



For all our latest catalogue updates and company info: www.tvh.be

BATTERY SAFETY PRODUCTS

ACID ABSORBER



REF./ 106TA9009
Ø 7,6 cm x 122 cm, 30/box
Absorbs ACID!

NEUTRACID

Absorber and extinguisher with indicator of neutralisation.

NeutrAcid absorbs liquids, neutralises acids. 1Kg of NeutrAcid is capable of neutralizing approx. 300 ml of concentrated sulphuric acid H_2SO_4 , approx. 600 ml of concentrated nitric acid HNO_3 , approx. 1000 ml of concentrated hydrochloric acid HCL.

When colour turns to yellow, neutralization is completed. One filling of box cap holds approx. 150g of NeutrAcid

REF./ 106TA9020



WATER / ACID CONTAINERS



REF./ 106TA8955 - 20 L
REF./ 106TA8954 - 50 L

EMERGENCY SHOWER



REF./ 106TA9019
emergency shower complete with eye wash bath - fixed unit



SAFETY GLASSES



REF./ 106TA9013
Acid resistant safety glasses

Plastic



REF./ 106TA9010
emergency shower - 200 x 200 mm
REF./ 106TA9011
eyeshower - 200 x 200 mm

ACID RESISTANT APRON



REF./ 106TA9018
acid resistant apron

GLOVES



rubber acid resistant gloves
size: **8:** **REF./ 106TA9014**
9: **REF./ 106TA9015**
10: **REF./ 106TA9016**
11: **REF./ 106TA9017**

REF./ 106TA9012
PORTABLE
emergency shower

